

TLP115

High Speed, Long Distance Isolated Line Receiver
 Microprocessor System Interfaces
 Digital Isolation For A / D, D / A Conversion
 Computer-Peripheral Interfaces
 Ground Loop Elimination

The TOSHIBA mini flat coupler TLP115 is small outline coupler, suitable for surface mount assembly.
 TLP115 consists of a GaAlAs light emitting diode, optically coupled to an integrated high gain, high speed shielded photo detector whose output is an open collector schottky clamped transistor.
 The shield, which shunts capacitively coupled common noise to ground, provides a guaranteed transient immunity specification of 1000V / μ s.

- Input current thresholds: $I_F=10\text{mA}$ (max.)
- Switching speed: 10MBd (typ.)
- Common mode transient immunity: $\pm 1000\text{V} / \mu\text{s}$ (min.)
- Guaranteed performance over temp.: 0~70°C
- Isolation voltage: 2500Vrms (min.)
- UL recognized: UL1577, file no. E67349

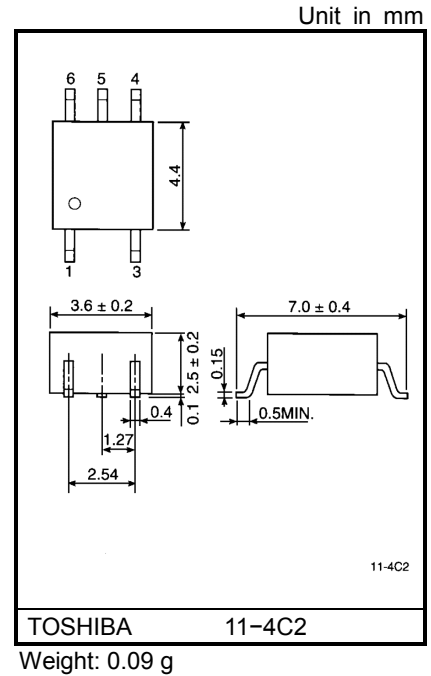

Schematic

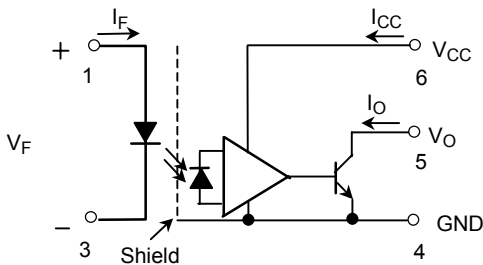

Note. A 0.1 μ F bypass capacitor must be connected between pins 4 and 6.

Pin Configuration(top view)

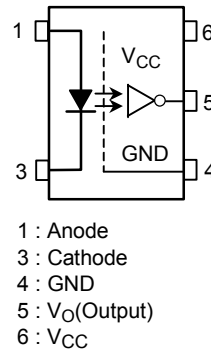

Truth Table(positive logic)

Input	Output
H	L
L	H

Maximum Ratings (Ta = 25°C)

Characteristic		Symbol	Rating	Unit
LED	Forward current	I_F	20	mA
	Pulse forward current (Note 1)	I_{FP}	40	mA
	Peak transient forward current (Note 2)	I_{FPT}	1	A
	Reverse voltage	V_R	5	V
Detector	Output current	I_O	25	mA
	Output voltage	V_O	7	V
	Supply voltage (1 minute maximum)	V_{CC}	7	V
	Output power dissipation	P_o	40	mW
Operating temperature range		T_{opr}	-40~85	°C
Storage temperature range		T_{stg}	-55~125	°C
Lead solder temperature(10s)		T_{sol}	260	°C
Isolation voltage (AC, 1min., RH ≤ 60%, Note 4)		BV_S	2500	Vrms

(Note 1) 50% duty cycle, 1ms pulse width.

(Note 2) Pulse width ≤ 1μs, 300pps.

Recommended Operating Conditions

Characteristic	Symbol	Min.	Typ.	Max.	Unit
Input voltage, low level	V_{FL}	-3	0	1.0	V
Input current, high level	I_{FH}	13	16	20	mA
Supply voltage	V_{CC}	4.5	5	5.5	V
Fan out (TTL load, each channel)	N	—	—	8	—
Operating temperature	T_{opr}	0	—	70	°C

Electrical Characteristics

(unless otherwise specified, $T_a = 0\sim 70^\circ\text{C}$, $V_{CC} = 4.5\sim 5.5\text{V}$, $V_{FL} \leq 1.0\text{V}$)

Characteristic	Symbol	Test Condition	Min.	Typ.*	Max.	Unit
Forward voltage	V_F	$I_F=10\text{mA}$, $T_a=25^\circ\text{C}$	—	1.65	1.80	V
Forward voltage temperature coefficient	V_F / T_a	$I_F=10\text{mA}$	—	-2	—	mV / °C
Reverse current	I_R	$V_R=5\text{V}$, $T_a=25^\circ\text{C}$	—	—	10	μA
Capacitance between terminals	C_T	$V_F=0$, $f=1\text{MHz}$, $T_a=25^\circ\text{C}$	—	45	—	pF
High level output current	I_{OH}	$V_F=1.0$, $V_O=5.5\text{V}$	—	—	250	μA
		$V_F=1.0$, $V_O=5.5\text{V}$, $T_a=25^\circ\text{C}$	—	0.5	10	
Low level output voltage	V_{OL}	$I_F=10\text{mA}$ $I_{OL}=13\text{mA}(\text{sinking})$	—	0.4	0.6	V
"H level output → L level output" input current	I_{FH}	$I_{OL}=13\text{mA}(\text{sinking})$ $V_{OL}=0.6\text{V}$	—	—	10	mA
High level supply current	I_{CCH}	$V_{CC}=5.5\text{V}$, $I_F=0$	—	7	15	mA
Low level supply current	I_{CCL}	$V_{CC}=5.5\text{V}$, $I_F=16\text{mA}$	—	12	18	mA
Input-output insulation leakage current	I_S	$V_S=3540\text{V}$, $t=5\text{s}$ $T_a=25^\circ\text{C}$ (Note 4)	—	—	100	μA
Isolation resistance	R_S	R.H. $\leq 60\%$, $V_S=500\text{V DC}$ $T_a=25^\circ\text{C}$ (Note 4)	5×10^{10}	10^{14}	—	Ω
Stray capacitance between input to output	C_S	$V_S=0$, $f=1\text{MHz}$ $T_a=25^\circ\text{C}$ (Note 4)	—	0.8	—	pF

* All typical values are $V_{CC}=5\text{V}$, $T_a=25^\circ\text{C}$

Switching Characteristics($V_{CC} = 5V$, $T_a = 25^{\circ}C$)

Characteristic	Symbol	Test Circuit	Test Condition	Min.	Typ.	Max.	Unit
Propagation delay time (H→L)	t_{pHL}	1	$I_F=0 \rightarrow 16mA$ $C_L=15pF, R_L=350\Omega$	—	60	120	ns
Propagation delay time (L→H)	t_{pLH}	1	$I_F=16 \rightarrow 0mA$ $C_L=15pF, R_L=350\Omega$	—	60	120	ns
Output rise fall time (10–90%)	t_r, t_f	2	$R_L=350\Omega, C_L=15pF$ $I_F=0 \rightleftarrows 16mA$	—	30	—	ns
Common mode transient immunity at high output level	CM_H	2	$I_F=0mA, V_{CM}=400V_{p-p}$ $V_{O(min)}=2V, R_L=350\Omega$	1000	—	—	V / μs
Common mode transient immunity at low output level	CM_L	2	$I_F=16mA, V_{CM}=400V_{p-p}$ $V_{O(max)}=0.8V,$ $R_L=350\Omega$	–1000	—	—	V / μs

(Note 4) Device considered a two-terminal device: Pins 1 and 3 shorted together, and pins 4, 5 and 6 shorted together.

(Note 5) The V_{CC} supply voltage to each TLP115 isolator must be bypassed by 0.1 μF capacitor. This can be either a ceramic or solid tantalum capacitor with good high frequency characteristic and should be connected as close as possible to package V_{CC} and GND pins of each device.

(Note 6) Maximum electrostatic discharge voltage for any pins: 180V(C=200pF, R=0)

Test Circuit 1: Switching Time Test Circuit

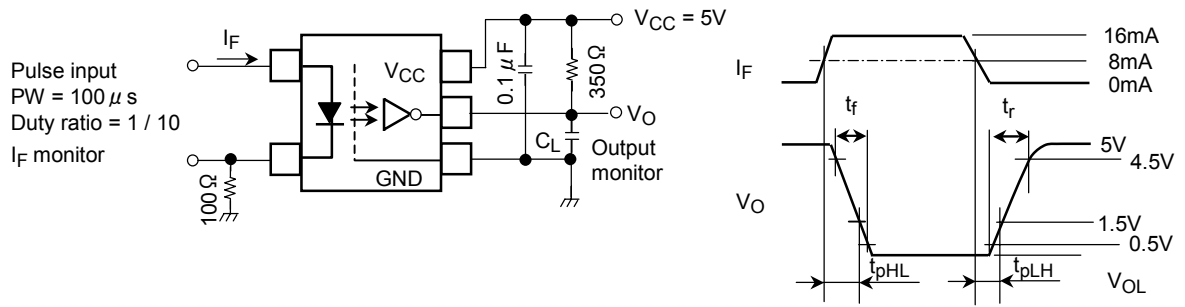

C_L is approximately 15pF which includes probe and stray wiring capacitance.

Test Circuit 2: Common Mode Transient Immunity Test Circuit

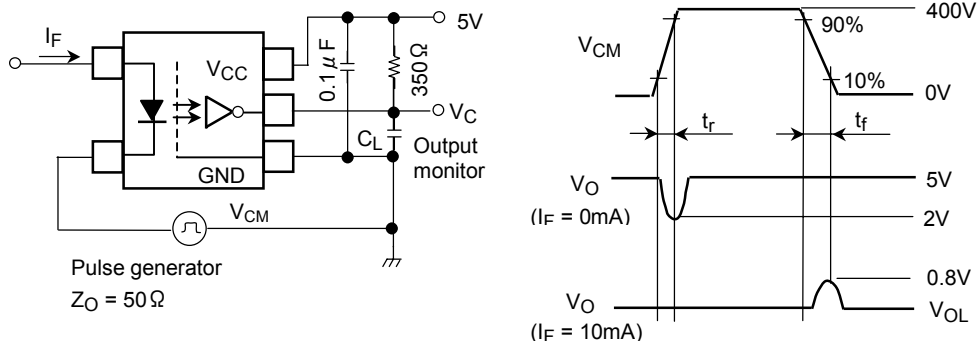

$$CM_H = \frac{320(V)}{t_r(\mu s)}, CM_L = \frac{320(V)}{t_f(\mu s)}$$

C_L is approximately 15pF which includes probe and stray wiring capacitance.

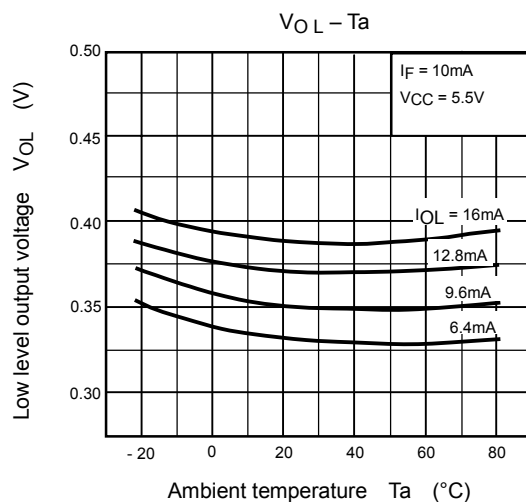
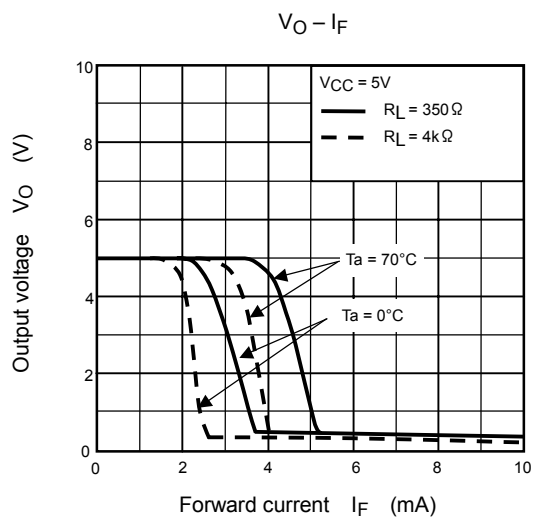
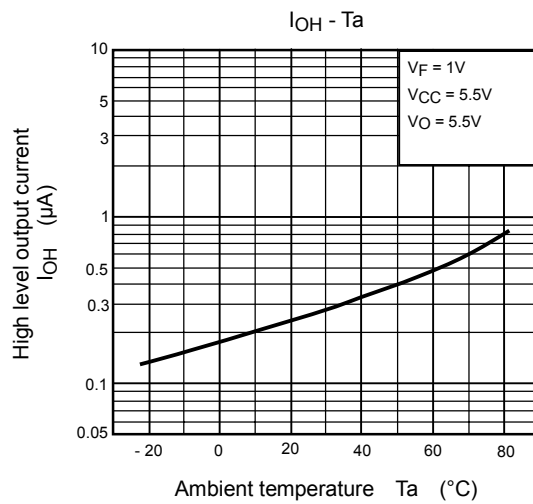
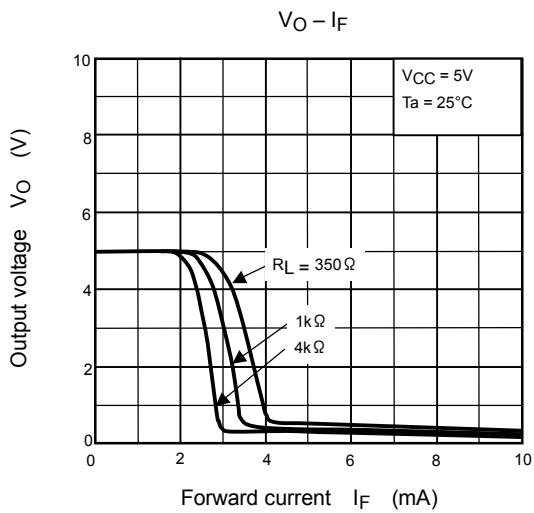
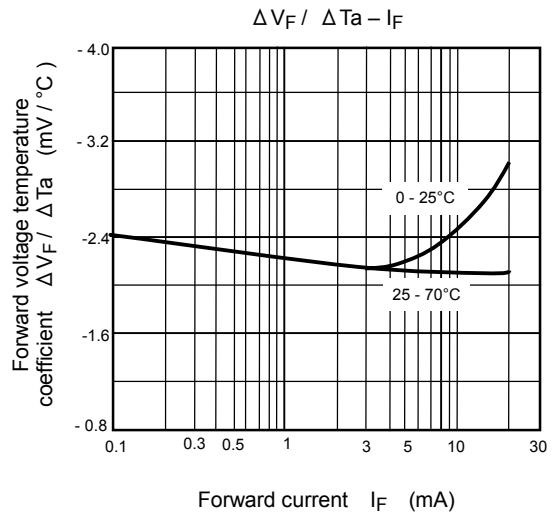
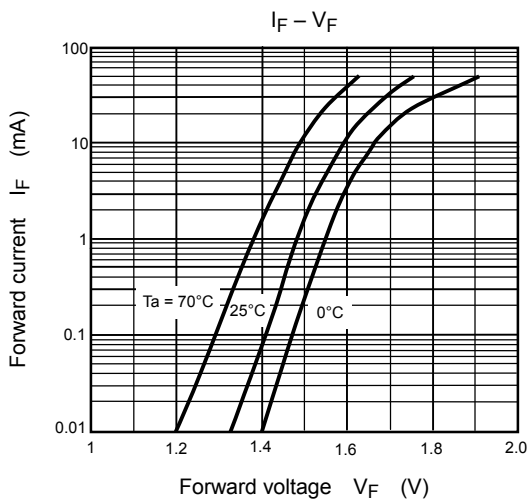

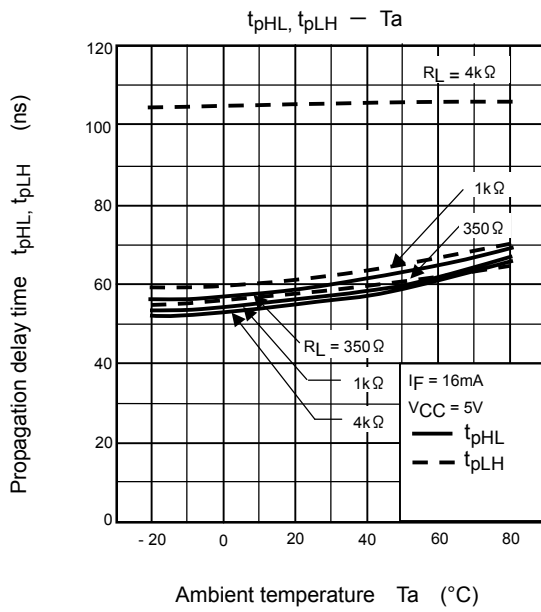
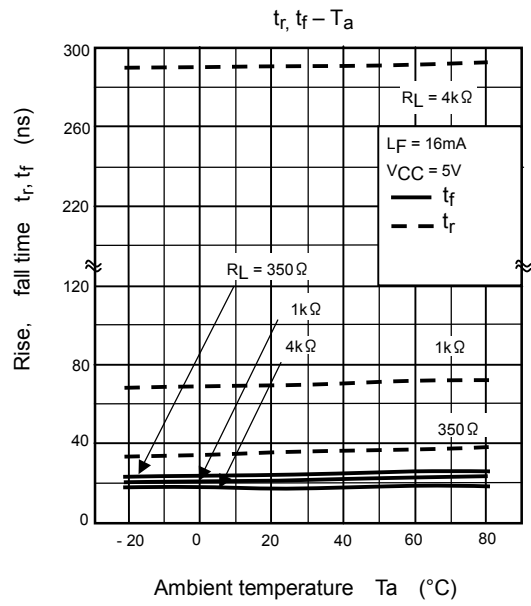
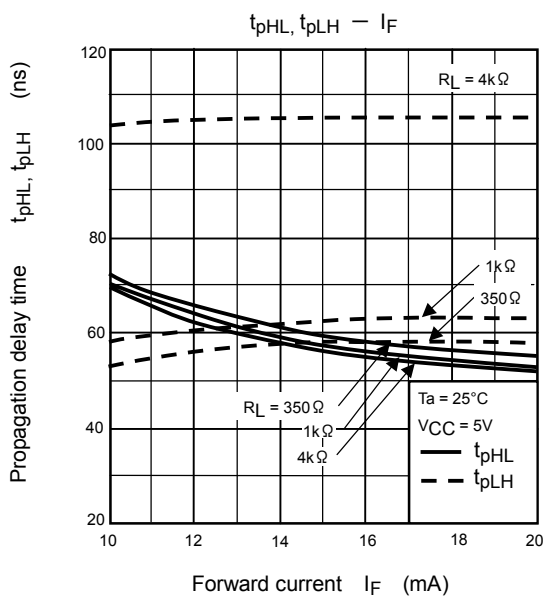

RESTRICTIONS ON PRODUCT USE

000707EBC

- TOSHIBA is continually working to improve the quality and reliability of its products. Nevertheless, semiconductor devices in general can malfunction or fail due to their inherent electrical sensitivity and vulnerability to physical stress. It is the responsibility of the buyer, when utilizing TOSHIBA products, to comply with the standards of safety in making a safe design for the entire system, and to avoid situations in which a malfunction or failure of such TOSHIBA products could cause loss of human life, bodily injury or damage to property.
In developing your designs, please ensure that TOSHIBA products are used within specified operating ranges as set forth in the most recent TOSHIBA products specifications. Also, please keep in mind the precautions and conditions set forth in the "Handling Guide for Semiconductor Devices," or "TOSHIBA Semiconductor Reliability Handbook" etc..
- The TOSHIBA products listed in this document are intended for usage in general electronics applications (computer, personal equipment, office equipment, measuring equipment, industrial robotics, domestic appliances, etc.). These TOSHIBA products are neither intended nor warranted for usage in equipment that requires extraordinarily high quality and/or reliability or a malfunction or failure of which may cause loss of human life or bodily injury ("Unintended Usage"). Unintended Usage include atomic energy control instruments, airplane or spaceship instruments, transportation instruments, traffic signal instruments, combustion control instruments, medical instruments, all types of safety devices, etc.. Unintended Usage of TOSHIBA products listed in this document shall be made at the customer's own risk.
- Gallium arsenide (GaAs) is a substance used in the products described in this document. GaAs dust and fumes are toxic. Do not break, cut or pulverize the product, or use chemicals to dissolve them. When disposing of the products, follow the appropriate regulations. Do not dispose of the products with other industrial waste or with domestic garbage.
- The products described in this document are subject to the foreign exchange and foreign trade laws.
- The information contained herein is presented only as a guide for the applications of our products. No responsibility is assumed by TOSHIBA CORPORATION for any infringements of intellectual property or other rights of the third parties which may result from its use. No license is granted by implication or otherwise under any intellectual property or other rights of TOSHIBA CORPORATION or others.
- The information contained herein is subject to change without notice.